

PROTEA CHANDELIERS | PROTEA - 500 - SUSPENDED | PROTEA-500-S



DESCRIPTION

A suspended chandelier inspired by the South Africa's national flower the 'Protea'. Made from lasercut stainless steel frames, chrome plated or lacquered, solid brass components and ballchain in several optional finishes. Illuminated by 7 surface mounted G9 Halogen lamps.

PRODUCT SIZE

SHADE SIZE: 500W X 500H MM / TOTAL HEIGHT: 900MM

PACKAGING DIMENSIONS

610MM(W) X 610MM(L) X 330MM(H)



LAMP TYPE & NO

7 X G9-HALOGEN 18-40 WATT LAMPS (126-280W) OR LED

CLASS I
IP RATING 20
QC RATING 21

VOLTAGE RANGE
110 - 240V

PRODUCT MARKS & RATINGS



WEIGHT 7KG
PACKED 12KG WEIGHT

TECHNICAL DRAWING

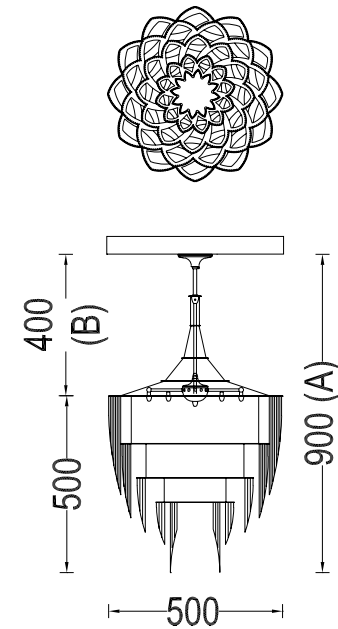

INTERACT

SELECT COLOUR

- SILVER *
- BRASS *
- COPPER *
- SMOKE *
- MIXED METALIC *
- RUST *
- WHITE
- RED
- BLACK

* METALLIC

CUSTOMISE DIMENSIONS

A

B

LAMP TYPE

QUANTITY

ADDITIONAL COMMENTS