

# MOROCCAN VASES | MOROCCAN VASE 4 LARGE - SUSPENDED | MOROCCAN-4-LRG-S



## DESCRIPTION

A collection of medium sized pendant lamps inspired by the forms of and colours of Moroccan metal vases. This version is the most elaborate and is illuminated by a G9 Halogen or G9 3W LED lamp within a Pyrex glass ball. Alternatively E27 LEDs can also be specified.

## PRODUCT SIZE

SHADE SIZE: 248W X 810H MM / TOTAL HEIGHT: 1320MM

## PACKAGING DIMENSIONS

610MM(W) X 610MM(L) X 330MM(H)



## LAMP TYPE & NO

1 X G9-HALOGEN 25-60 WATT LAMPS (33-60W) OR  
G9 3W LED - OR 1 X E27 LED

CLASS II  
IP RATING 54  
QC RATING 21

VOLTAGE RANGE  
110 - 240 V

PRODUCT  
MARKS &  
RATINGS



WEIGHT 2.2KG  
PACKED 7.2KG  
WEIGHT

## TECHNICAL DRAWING

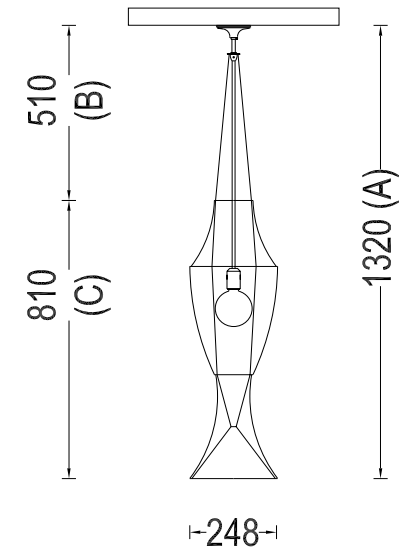

## INTERACT

### SELECT COLOUR

- SILVER \*
- BRASS \*
- COPPER \*
- SMOKE \*
- MIXED METALIC \*
- RUST \*
- WHITE
- RED
- BLACK

\* METALLIC

### CUSTOMISE DIMENSIONS

A

B

### LAMP TYPE

QUANTITY

### ADDITIONAL COMMENTS

WEB LINK